

1" Assembly Instructions for Bimini & Buggy Tops

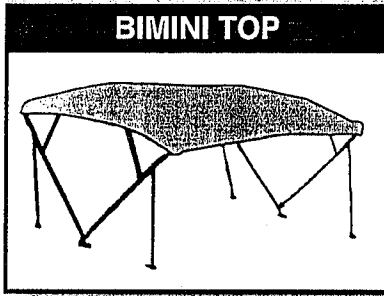

BIMINI TOP

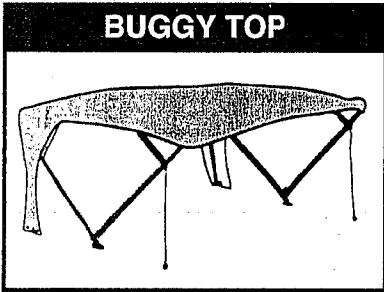

BUGGY TOP

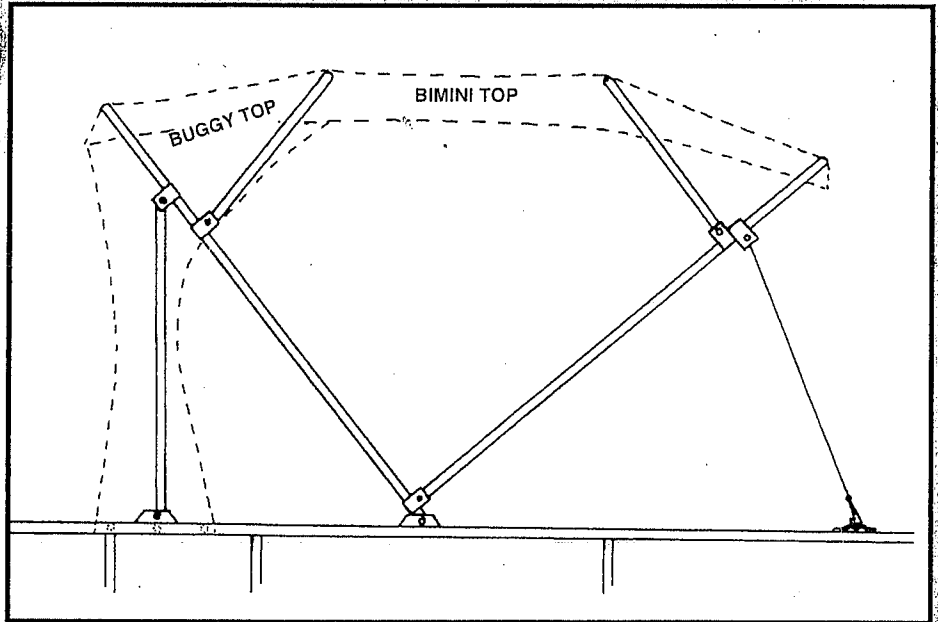

NOTE: This is a universal fit unit. You may need to improvise in some areas to secure this unit to your boat.

Parts List (not actual size)

1 - Right Side Bow Assembly



1 - Left Side Bow Assembly

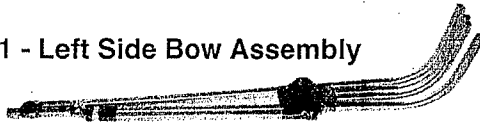

4 - Center Bow Pieces

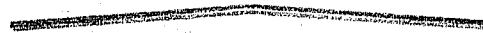

1 - Bimini or Buggy Top & Boot



Mounting Hardware Kit Consisting of:

Parts Shown 50% Scale

8 - 6" Joiner Pieces

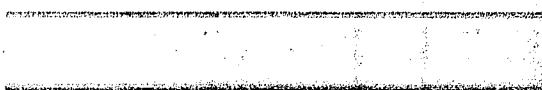

1 - Wire Harness

4 - Butt Connectors

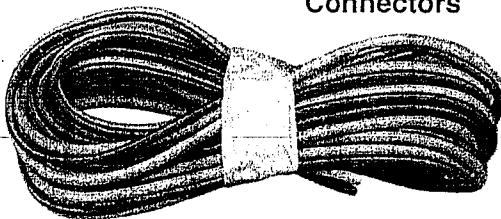

4 - Deck Mounts

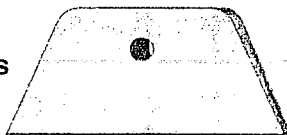

Parts Shown Actual Size

32 - Tech Screws

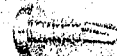

1 - White Grommet



2 - Strap Eyes



8 - #10 x 3/4 x 1-3/4 Phillips Pan Bolts



4 - #10-24 x 1-3/4 Phillips Oval Head Bolts

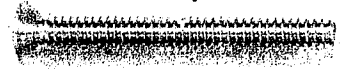

1 - Grey Cap



12 - #10 x 24 Lock Nuts



Assembly Instructions for Bimini & Buggy Tops

IMPORTANT: It is crucial to carefully follow these instructions in order!

- 1** Stretch the fabric out flat on a clean dry surface upside down and find the rear by locating the pre-cut hole for the stern light.
SEE FIG. 1

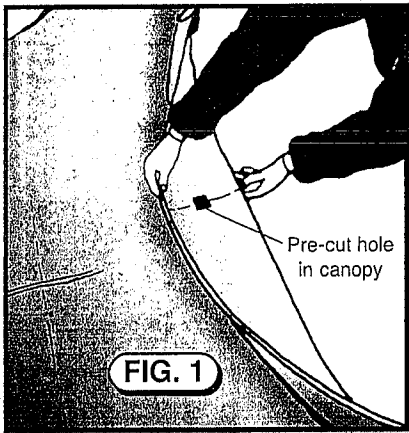

- 2** Locate the rear center bow piece (It has the pre-drilled hole in the center for the stern light wire.) and insert it into the rear sleeve of the canopy. SEE FIG. 2

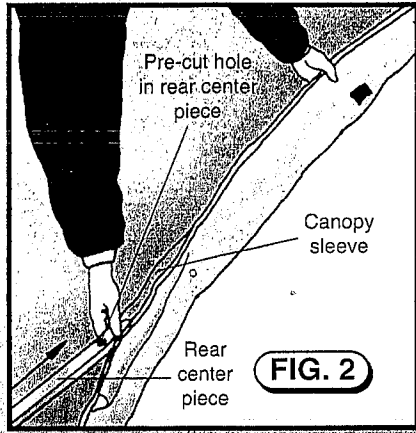

- 3** Insert the other 3 center bow pieces into the remaining 3 sleeves of the canopy. SEE FIG. 3

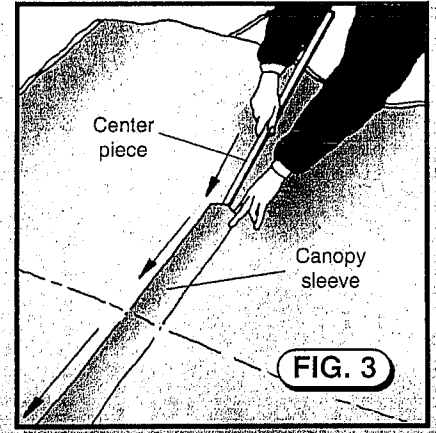

- 4** Locate the 6" joiner pieces. Attach 4 joiners into the bows on what will be the wired side of the frame only for now. Attach the joiner pieces to the center bow pieces with the tech screws provided. (2 screws per side) Note: joiner piece extends approx. 3" into each piece. SEE FIG. 4

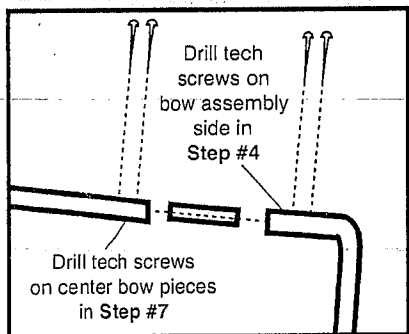
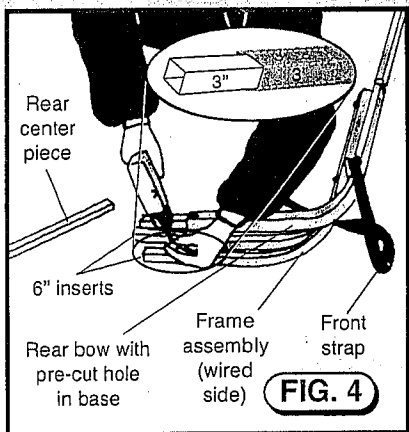

- 5** Slide one end of the wire harness through the white plastic grommet (FIG. 5), then insert the same end into the pre-drilled hole in the center bow piece (FIG. 6). Feed the wire completely through until it comes out the opposite end (FIG. 7). Push grommet into hole (FIG. 8).

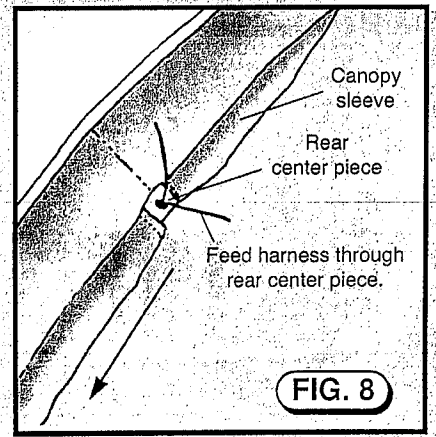
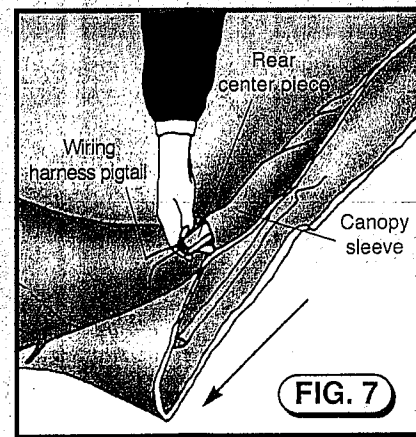
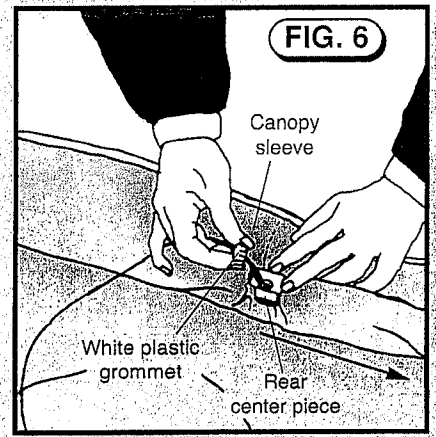
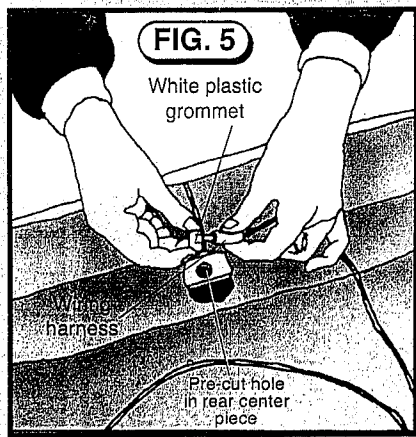

- 6** Slide the wire into the top (open end of the radius) of the bow with the pre-drilled hole in its base. Feed the wire through the entire length of the bow until it exits the base. **SEE FIG. 9**

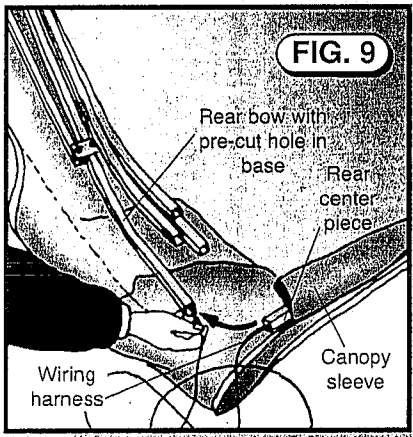

NOTE: (2 people suggested for Steps #10-11)

- 10** Place the assembled canopy and frame into the deck mounts and line up the pre-drilled holes in the bow frame and deck mounts. Insert the pull pins provided. **SEE FIG. 11**

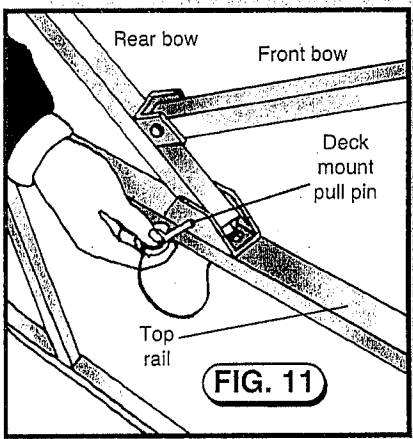

- 7** Spread the wired side of the frame apart and line up its bows with their center pieces in place in the canopy sleeves. (Strut to the rear, straps to the front.) Secure the bows and center pieces with tech screws. **SEE FIG. 15 ON BACK.**

- 9** Determine the area on your boat you wish to cover. Attach deck mounts to the top rail corresponding to the covered area (approximately centered to the length of your top) with 2 pan bolts and nuts per each. **SEE FIG. 15 ON BACK.** Do not locate them in front of the gate or obstruct the gateway. **WHEN INSTALLING THE DECK MOUNTS, MARK THE POSITION FOR THE 2 HOLES ON TOP RAIL, AND DRILL COMPLETELY THROUGH THE RAIL. SEE FIG. 10.**

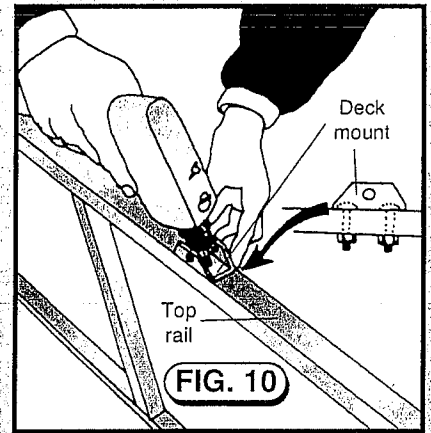

- 11** Line up the rear struts perpendicular to the top rail. Mark the position for the 2 holes in each mount on the top rail and drill completely through the rail. Attach both rear deck mounts with nuts and pan bolts. Swing struts into position in the rear deck mounts, line up the pre-drilled holes and insert the pull pins. **SEE FIG. 12**

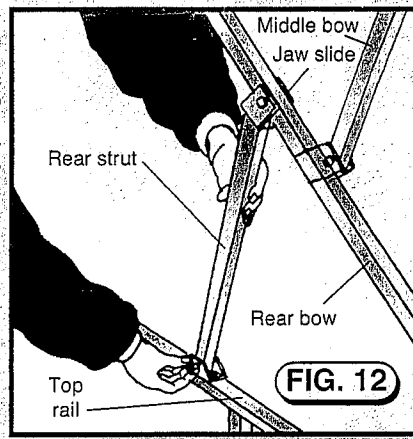

- 12** Locate the attached front straps and stretch them forward along the top rails to position the strap eyes. Mark the holes and attach with oval-head bolts. Do not locate them in front of the gate or obstruct the gateway. Snap the snap hooks to the strap eyes. **SEE FIG. 13-14**

If you are assembling a bimini top, your assembly is now complete. If you are assembling a buggy top, proceed to STEP #13 on back.

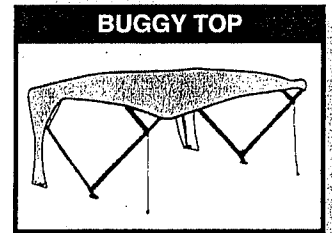
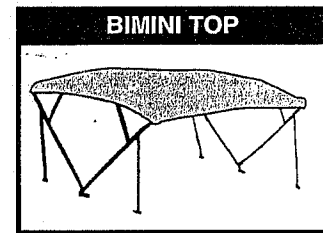
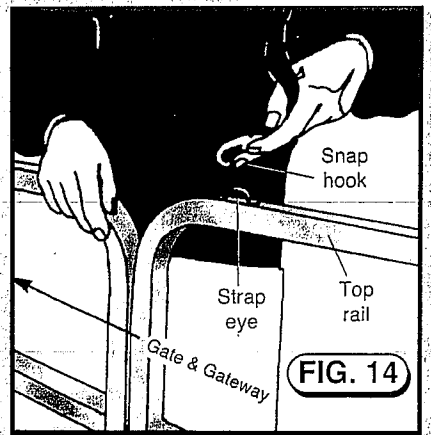
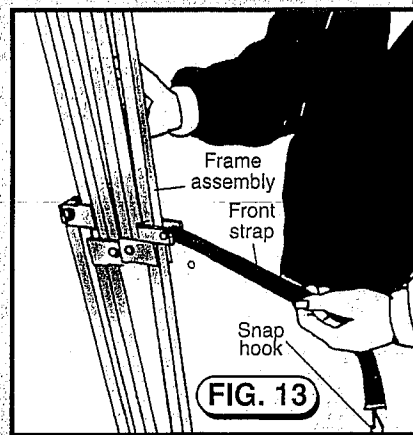

Assembly Instructions for Buggy Tops continued

IMPORTANT: It is crucial to carefully follow these instructions in order!

13 On a buggy top, there are 2 rear tail pieces attached to the canopy. Stretch out the tail until it is taut and the rear snap lines up to the center of the side of the top rail. Starting with the rear snap, mark the snap's center and screw into place and snap. Stretch the front snap forward until the tail piece is wrinkle free, mark the center of the front snap, screw into place and snap. **Install the middle snap last.** Repeat on the other side and your buggy top assembly is complete.

SEE FIG. 15 BELOW

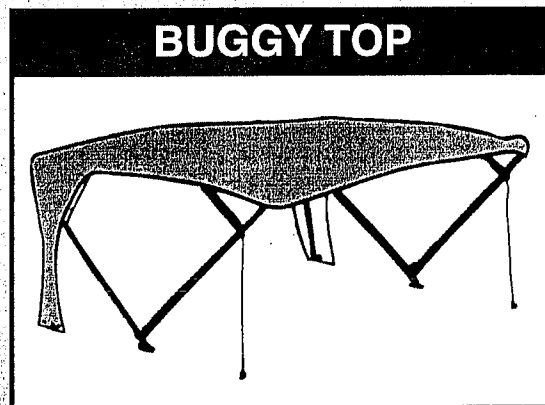

If you have a BUGGY TOP...

(with tail pieces - picture above), DO NOT attach the rear strut as shown in FIG. 13. Let the rear struts dangle loose and level the top by tightening or loosening the front straps. Stretch the tail pieces down until the snaps line up with the center of the top rail, as in Step 13. Check the rear strut length. Due to different configurations, it may be necessary to shorten the rear strut. Simply move it in place, mark the correct length and cut off with a hacksaw.

If you have a BIMINI TOP...

(with no tail pieces), level the top with the front straps and check the rear strut length. It may be necessary to cut them off (as above) to insure the top is level. **Your unit may be equipped with a quick spring pin disconnect system** on your rear upright. If so, it will replace the need for a pull pin at this location. Should you need to cut anything off of the strut, remove the strut, at the jaw slide bracket, cut to desired length and drill new hole & replace.

